

SafeCase™ iPhone 12 Quick Start Guide

DO NOT VOID YOUR WARRANTY. Please read the information included before using.

SETUP

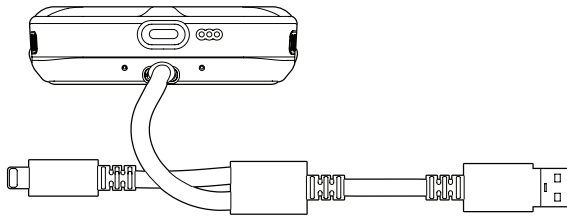

STEP 1

Connect SafeCase to a USB power source (computer or power adapter) using the included two-headed charging cable.

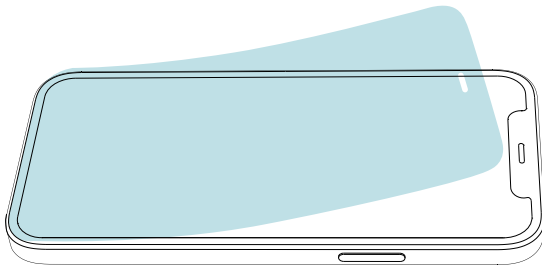

STEP 2

If applicable, **remove the screen protector and/or protective case from your iPhone.**

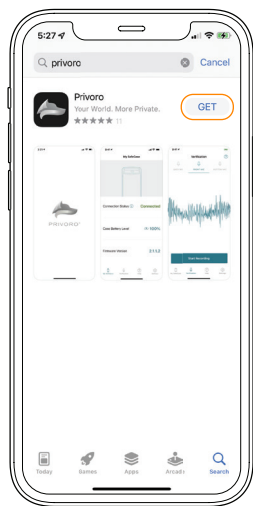

STEP 3

Download the Privoro app from the App Store. Open the app and follow the on-screen prompts to pair to your SafeCase.



SETUP CONTINUED

STEP 4

Insert your iPhone into SafeCase. **Pull the latch slide to the left**, unlocking the base tray.

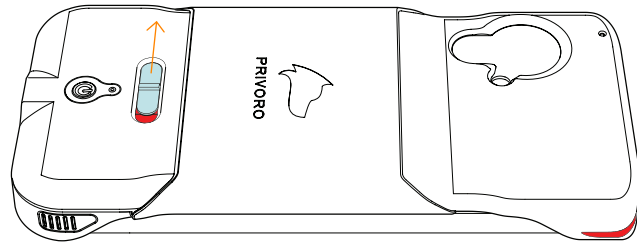

STEP 5

Gripping the sides, **slide the base tray until it's fully extended**.

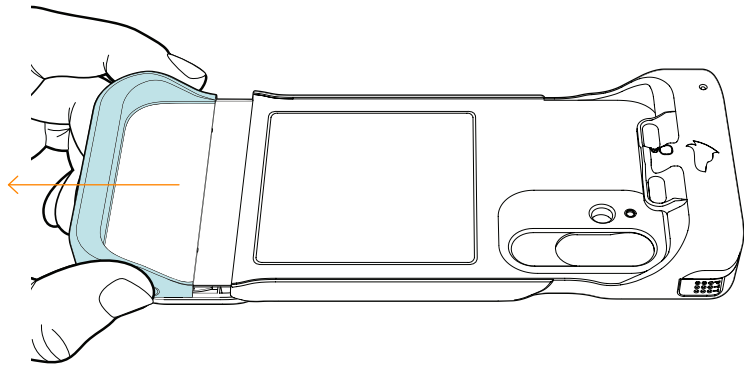

STEP 6

Tuck your iPhone head-first into SafeCase and then rest your phone onto the tray.

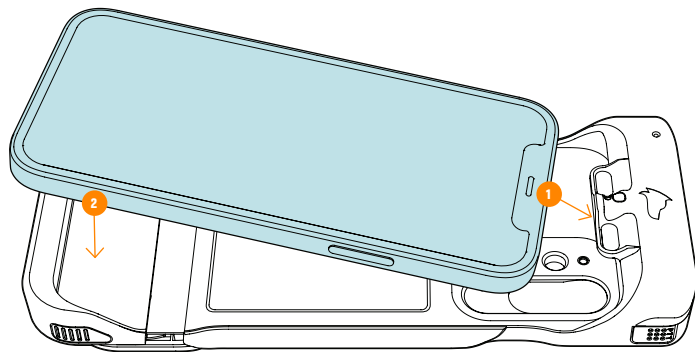

STEP 7

Push up from the bottom of the base tray until it clicks into place.

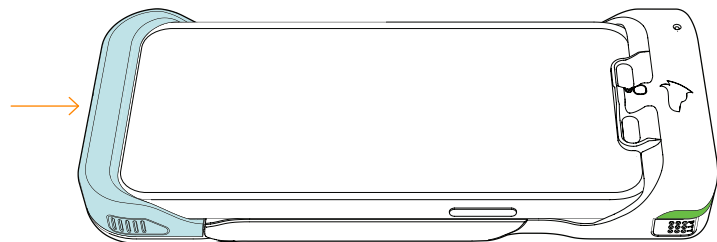

MAINTAINING AUDIO/VIDEO PROTECTIONS

When SafeCase is powered on, audio/video surveillance protections are automatically engaged, as indicated by the corner indicator LEDs pulsing green. To maintain these protections, simply **keep your SafeCase charged**.

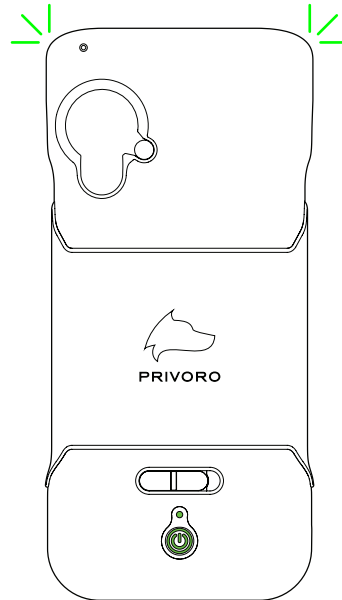

USING YOUR PHONE OR CAMERA

To place or receive a phone/video call or capture images/video/audio, protections must first be disengaged. To disengage protections, **swipe left (with the phone facing you) across the touch bar, toward the unlocked icon**.

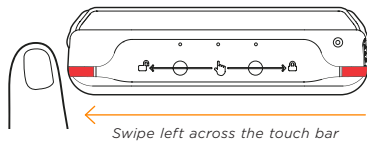

When ready to reengage protections, **swipe right (with the phone facing you) across the touch bar, toward the locked icon**.

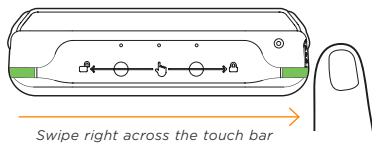

CHECKING SAFECASE STATUS

To check SafeCase battery level and app pairing status, **open the My SafeCase screen** in the Privoro app.

